

INFORMAZIONI TECNICHE

Altezza (in mm) : 42
Categoria : A soffiatti
Corsa : 25 mm
Diametro del collo interno : 6mm
Diametro labbro : 40 mm
Forma : 4,5 soffiatti
Forza orizzontale : 51 N
Forza verticale : 25.5 N
Gamma : Ventosa
Numero di soffiatti : 4,5 soffiatti
Serie : 92

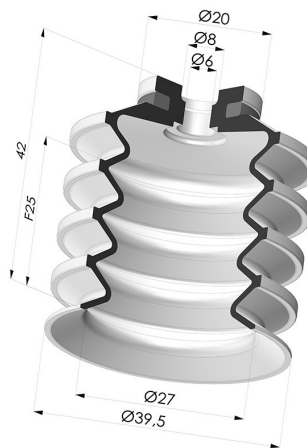

Varianti:



Riferimento variante:
92 40SL A

- Colore: Rosso Certificato alimentare CE
- Durezza Shore: SH 60
- Materiale: Silicone



Riferimento variante:
92 40NI A

- Colore: Nero
- Durezza Shore: SH50
- Materiale: Nitrile



Riferimento variante:
92 40SLT A

- Colore: Trasparente Certificato alimentare CE
- Durezza Shore: SH 60
- Materiale: Silicone

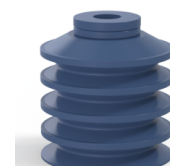

Riferimento variante:
92 40SLDB A SH60

- Colore: Blu Certificato alimentare CE
- Durezza Shore: SH 60
- Materiale: Silicone rilevabile

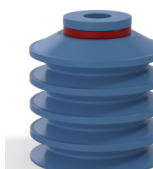

Riferimento variante:
92 40SLBLEU A





- Colore: Blu Certificato alimentare CE
- Durezza Shore: SH50
- Materiale: Silicone

Guida ai materiali:

	Materiale	Codice	Resistenza temperatura (°C)	Flessibilità	Resistenza abrasione	Resistenza UV/Intemperie	Resistenza oli	Compatibilità alimentare	Test di migrazione
	Silicone Rosso Certificato alimentare CE	SL	-60/+250	✓✓✓	✗	✓✓✓	✗	FDA ☞☞	A, B, D2
	Nitrile Nero	NI	-10/+80	✓	✓	✗	✓✓	✗	✗
	Silicone Trasparente Certificato alimentare CE	SLT	-60/+250	✓✓✓	✗	✓✓✓	✗	FDA ☞☞	✗
	Silicone rilevabile Blu Certificato alimentare CE	SLDB	-60/+250	✓✓✓	✗	✓✓✓	✗	FDA ☞☞	A, B, D2

	Silicone Blu Certificato alimentare CE	SLBLEU	-60/+250	✓✓✓	✗	✓✓✓	✗		A, B, D2
--	--	--------	----------	-----	---	-----	---	--	----------

Le richieste di certificati FDA e/o CE devono essere effettuate OBBLIGATORIAMENTE al momento dell'ordine. Una richiesta successiva comporterà costi aggiuntivi. Per soddisfare le aspettative dei nostri clienti industriali, NOVACOM dispone della più ampia gamma di materiali elastomerici o termoplastici. Possiamo inoltre sviluppare nuovi materiali secondo un capitolato tecnico preciso, al fine di risolvere applicazioni specifiche per i nostri clienti.

 Eccellente |
  Buona |
  Media |
  Bassa |
  Non raccomandato
 *È possibile richiedere un certificato FDA e/o CE su diverse referenze al momento dell'ordine; contattateci.
 ** Certificazione per contatto alimentare: (CE) 1935/2004 - (FDA) 21 CFR 177.2600
 *** Certificazione per contatto alimentare: (CE) 10/2011 - (FDA) 21 CFR

Prodotti correlati:



Ventosa 4.5 Soffiatti Serie 92 Ø 40MM
 Riferimento prodotto: 92 40-- 18



Anello di Rinforzo - Øest 35.8MM
 Riferimento prodotto: A40



Ventosa 4.5 Soffiatti Serie 92 Ø 40MM
 Riferimento prodotto: 92 40-- 14D-2



Ventosa 4.5 Soffiatti Serie 92 Ø 40MM
 Riferimento prodotto: 92 40-- 14D-2-F



Ventosa 4.5 Soffiatti Serie 92 Ø 40MM
 Riferimento prodotto: 92 40-- 14D-2-GIC



Ventosa 4.5 Soffiatti Serie 92 Ø 40MM
 Riferimento prodotto: 92 40-- 18D-2



Ventosa 4.5 Soffiatti Serie 92 Ø 40MM
 Riferimento prodotto: 92 40-- 18D-2-F



Ventosa 4.5 Soffiatti Serie 92 Ø 40MM
 Riferimento prodotto: 92 40-- 18D-2-GIC



Ventosa 4.5 Soffiatti Serie 92 Ø 40MM
 Riferimento prodotto: 92 40-- 18D-3-BD



Ventosa 4.5 Soffiatti Serie 92 Ø 40MM
 Riferimento prodotto: 92 40-- 38D-2



Ventosa 4.5 Soffiatti Serie 92 Ø 40MM
 Riferimento prodotto: 92 40-- 38D-2-F



Ventosa 4.5 Soffiatti Serie 92 Ø 40MM
 Riferimento prodotto: 92 40-- 38D-2-GIC