

**TECHNICAL INFORMATION**

<b>Arrow :</b>	10 mm
<b>Category :</b>	With bellows
<b>Contact lip diameter :</b>	22.2 mm
<b>Height (in mm) :</b>	25
<b>Horizontal force :</b>	13 N
<b>inner barrel diameter :</b>	M5
<b>Number of bellows :</b>	1.5 Bellows
<b>Range :</b>	Suction cup
<b>Series :</b>	91
<b>Shape :</b>	1.5 Bellows
<b>Vertical force :</b>	6.5 N

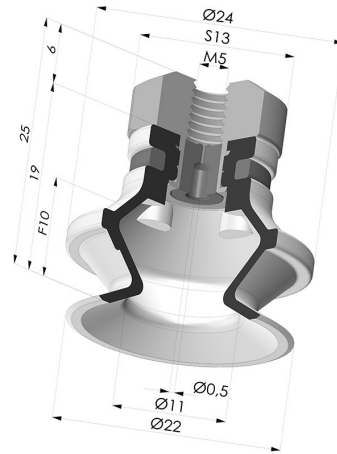

**Variants:**



Variant reference:  
**91 20SL FM5GIC**

- Color: Red food-grade CE certification
  - Matter: Silicone
  - Shore Hardness: SH60



Variant reference:  
**91 20SLT FM5GIC**

- Color: Translucent
  - CE food certified
  - Matter: Silicone
- Shore Hardness: SH60



Variant reference:  
**91 20NI FM5GIC**

- Color: Black
  - Matter: Nitrile
- Shore Hardness: SH50

**Related products:**

**Bellows Suction Cup 1.5 folds Series 91, Ø 20 mm**  
 Product reference: 91 20-- A

**Separable Female Fitting M5 - with Spray Nozzle**  
 Product reference: 9PM5-2-GIC