

TECHNICAL INFORMATION

Arrow :	15 mm
Category :	With bellows
Contact lip diameter :	100 mm
Height (in mm) :	44
Horizontal force :	331 N
inner barrel diameter :	Male G3/8"
Number of bellows :	1.5 Bellows
Range :	Suction cup
Series :	8SB
Shape :	1.5 Bellows
Vertical force :	165.5 N

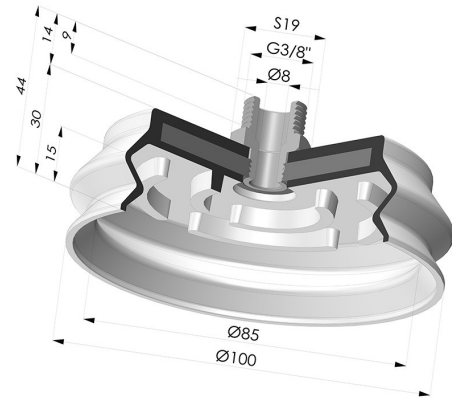

Variants:



Variant reference:
8SB 100SLT M38

- Color: Translucent
- CE food certified
- Matter: Silicone
- Shore Hardness: SH60



Variant reference:
8SB 100NI M38

- Color: Black
- Matter: Nitrile
- Shore Hardness: SH50