

TECHNICAL INFORMATION

Arrow :	4.5 mm
Category :	Plates
Contact lip diameter :	51.5 mm
Height (in mm) :	22
Horizontal force :	89.59 N
inner barrel diameter :	8 mm
Mass :	16 g
Number of bellows :	0.5 Bellows
Range :	Suction cup
Series :	VPC
Shape :	Plate
Vertical force :	44.80 N
Volume :	7.19 cm ³

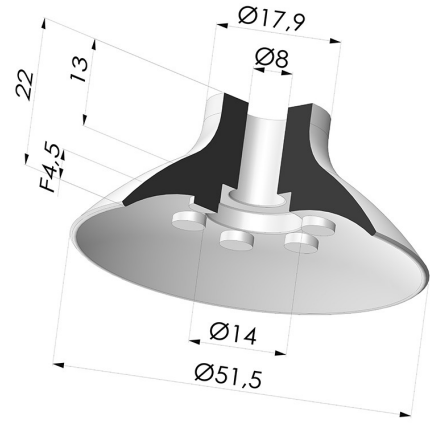

Variants:



Variant reference:

VPC 50NI A

- Color: Black
- Matter: Nitrile
- Shore Hardness: SH50



Variant reference:

VPC 50SLT A

- Color: Translucent
- CE food certified
- Matter: Silicone
- Shore Hardness: SH60



Variant reference:

VPC 50MNT A

- Matter: Non-staining material for plastics processing
- Shore Hardness: SH60

Related products:

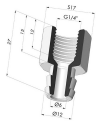

Separable Female Fitting G1/4"

Product reference: D



Separable Male Fitting G1/4"

Product reference: E

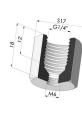

Adaptor - Female G1/4" - Female M6

Product reference: F14F6



Adaptor - Female 1/8G - Female M6

Product reference: F18F6

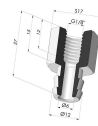

Separable Female Fitting G1/8"

Product reference: H

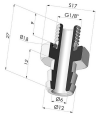

Separable Male Fitting G1/8"

Product reference: I

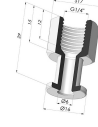

Crimped Female Fitting G1/4"

Product reference: L

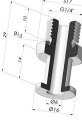

Crimped Male Fitting G1/4"

Product reference: M

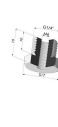

Adaptor - Male 1/4G - Female M6

Product reference: M14F6



Adaptor - Male 1/8G - Female M6

Product reference: M18F6



Screw M5 - Head Ø 14 mm - L 20.5 mm

Product reference: M5



Screw M6 - Head Ø 14 mm - L 20.5 mm

Product reference: M6



Crimped Female Fitting G1/8"

Product reference: R



Crimped Male Fitting G1/8"

Product reference: S



Screw M8 - Head Ø 14 mm - L 20 mm

Product reference: M8T14L20.5